



KRAL AV

AV SANAYİ MÜTEAHHİTLİK TIBBİ MALZ. SAN ve TİC. LTD. STİ.



Tel.: (0.332) 524 66 28 - 524 68 70 - Fax.: 524 68 71
Meydan Mah. Çeşme Sokak ÜZÜMLÜ.- BEYŞEHİR - KONYA

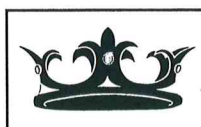

KRAL AV

AV SANAYİ MÜTEAHHİTLİK TIBBİ MALZ. SAN ve TİC. LTD. STİ.



**INSTRUCTION MANUAL
FOR SIDE BY SIDE**

**READ THE INSTRUCTIONS AND
WARNINGS IN THIS MANUAL CAREFULLY
BEFORE USING THIS FIREARM**

GUN SAFETY RULES

Observe these rules of safe gun handling.

1. Always keep the muzzle pointed in a safe direction. Watch the muzzle at all times: never point a gun, accidentally or intentionally, at any person or anything you do not intend to shoot. Identify the target before shooting; do not shoot at sounds.
2. Always treat any gun as if it is loaded it may be!
3. Keep your finger off the trigger while operating the action and at all other times until you are ready to shoot.
4. Keep the safety "on" or in the "safe" position at all times until you are ready to fire the gun. Move the safety to the "Off" or "Fire" position only when you intend to shoot.

Do not rely on your gun's safety, the safety on any gun is a mechanical device and is not intended as a substitute for common sense or safe gun handling.

5. Learn how your gun functions and handles. If you do not thoroughly understand the proper use and care of your gun, seek the advice of someone who is knowledgeable.
6. Do not alter or modify any parts of a firearm.
7. Store guns unloaded, separate from any ammunition, and where children cannot get to them.
8. Be sure the barrels are clear of any obstructions before loading. Make it a habit to check both barrels every time before loading.
9. Be sure you have and use the proper ammunition. A 20 gauge shell will enter a 12 gauge chamber far enough so that a 12 gauge shell can be loaded behind it. Also, a 3 inch shell may fit into a 2 3/4 inch chamber, but the crimp at the mouth of the shell will unfold into the forcing cone. If either of these things occur and you fire the gun, the gun will explode, damaging the gun and possibly causing serious injury or death to you and those around you.
10. Wear protective shooting glasses and adequate ear protection when shooting.
11. Never climb or jump over anything, such as a tree, fence or ditch, with a loaded gun. Open the barrels, remove the shells, and hand the gun to a friend or place it on the ground on the other side of the obstacle before crossing it yourself. Do not lean a gun against a tree or other object; it could fall and possibly discharge.

12. Do not shoot at a hard surface or at water. Bullets and shot can ricochet or bounce off and travel in unpredictable directions with great velocity.

13. Never transport a loaded gun. Do not place a loaded gun into a vehicle. The gun should be unloaded and placed into a case when not in use.

14. Never drink alcoholic beverages before or during shooting.

INTRODUCTION TO

For many years, Kral Av has been producing quality shotguns. Combine the old world quality with modern technology, and you have a product of true value and affordable quality. You have Kral Av Shotguns.

We at Kral Av thank you for the privilege of delivering a product to you that will provide you with years of pleasurable use. Happy shotgunning.

ABOUT YOUR DOUBLE BARREL SHOTGUN

Double barrel shotguns are made in two styles. Over/under shotguns have barrels that are stacked one on top of the other. Side-by-side shotguns have barrels positioned to the side of each other.



Two firing mechanisms are available in these double barrel shotguns. Boxlocks house the firing mechanism behind a false breech and are enclosed in a metal frame.

The extractor elevates the head of a live shell from the chamber so it can be removed.

Triggers come in single selective. The single selective works like the single, except it has a button that allows you to select the barrel to be fired first.

USAGE OF CHOKE TUBES

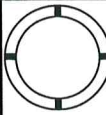
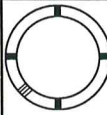
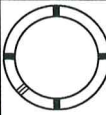
The choke is what controls the openness or tightness of the pattern of your shotgun. The chart below lists the chokes available (from open to tight), and the corresponding marks that indicate the choke of your specific shotgun.

	SKEET	IC	M	IM	F
CHOKE TUBE					
BBLs	CL	****	***	**	*

Never fire or run gun cleaning tools through a barrel that uses choke tubes without having a choke tube installed. The threads of the choke tube and the internal threads of the barrel should be cleaned after each use and before installation of the tube.

To install a tube, insert the tube into the barrel and tighten with your fingers. Once the tube is finger tightened, tighten with the appropriate choke-tube wrench until the tube is snug. DO NOT over tighten or forcefully tighten with wrench.

ASSEMBLY

Make sure there are no shells in the chamber.

1. Remove all dirt and excess oil from the gun, especially from the breech area, also barrel interior and ends.
2. Remove the forearm by pushing the forehead iron catch upwards. Allowing the nose of the forearm to release and pull it with the other hand at the same time to separate the forearm from the barrel. (Photos 1)

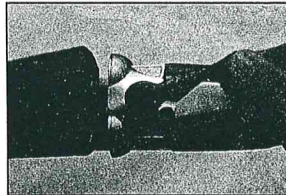

3. Lightly oil the already cleaned contact points. Attach barrels to action by grasping the grip of the stock with your right hand and placing the stock under your right arm. With your right thumb move the opening lever to the right. Now hold the barrels with your free hand and slide the barrels through the top of the receiver, with the barrels nose pointing down, until the hinge notch engages with the hinge pins. (Photos 2)

3

4. Keeping the hinge pin notch engaged with the hinge pin. lift the nose of the barrels until the action closes. Caution: If as you attempt to close the gun the barrels bind or don't seem to fit then the hinge pin and notch are not engaged. DO NOT FORCE, try again. Release the hinge pin and notch, and the barrels will be locked in place.

5. Replace the forearm on the gun by sliding the rear of the forearm into the barrel at the same angle by which you removed it. The round rear of the forearm should match the round front of the receiver, lift the nose of the forearm until it engages with the barrels with an audible click. If it does not click, slap the forearm with the palm of your hand. If the forearm release latch protrudes after the click, gently push it in place. (Photos 3)

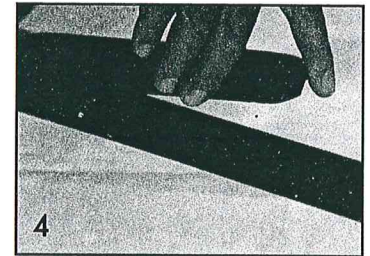
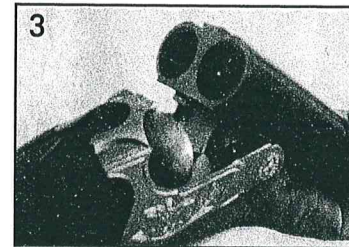

LOADING AND OPERATING YOUR SHOTGUN

1. Slide the safety, located on the tang of the receiver, toward the butt of the gun into the "Safe" position. (Photo 4)
 2. Break open the action.
 3. Check the barrels for any obstructions, including dirt and excess oil. Caution: Obstructions can increase barrel pressure sufficiently so that the barrel can explode when the gun is fired. This may result in serious injury or death to the shooter and others in the vicinity.
 4. Insert shot shells into the chamber or chambers you plan to fire. Caution: Make sure the shells are of the proper gauge and chamber length for your gun.
- Kral Av is not responsible for damage to gun or shooter caused by malfunctioning ammunition, new, remanufactured, reloaded, or hand loaded.
5. Close the action.
 6. The order in which the barrels are fired depends upon the type of trigger.

4

With a selective trigger, the user determines which barrel is fired first by selecting it with the selector button. Moving the button to the right selects the right barrel to fire first on side by side shotgun. Moving the button to the left selects the left barrel to fire first on side by side shotgun.

7. When contemplating firing your gun, be sure of your target, what is behind it, and the location of all persons with you or in your vicinity. Pick your target, release safety by sliding it forward with your thumb, and squeeze the trigger with your forefinger.

8. To unload, perss the opening lever to the right and open the action. Models with extractors only will elevate both fired and unfired shells above the chamber.

Caution: In case of a misfire, wait at least 30 seconds while keeping the gun pointed in a safe direction. Then, carefully open the action away from yourself and others. If the primer or rim is indented, the shell should be discarded in a manner that would prevent accidental injury to you or others. If there is no indentation the primer or rim, your gun has malfunctioned and should be serviced by a qualified gunsmith. If the gun is under warranty it must be serviced by an Authorized Warranty Repair Station.

DISASSEMBLY

1. Make sure the gun is unloaded and no shells are in the chambers.
2. Close the action. Place the gun butt on your thigh and remove the forearm by pulling the forearm release latch or pressing forearm release button. While pulling the nose of the forearm away from the barrels, slide the forearm forward until separated from the barrels.
3. Separate the barrels from the receiver by holding the stock of the gun in your right hand and the barrels in your left. Push the opening lever to the right with your thumb. Allow the nose of the barrels to drop and lift the barrels upward out of the receiver.
4. The gun can now be cleaned. The forearm should be reattached to the barrels for storage.

Caution: No further disassembly is needed, unless it is done by persons qualified in shotgun repair. Improper functioning and damage to the gun may result otherwise.

MAINTENANCE AND CLEANING

Caution: Make sure the gun is unloaded.

1. Make sure that the broad, polished, finely fitted mating surfaces of the breech block and receiver are especially clean and lightly oiled with a high quality gun oil. Do not use pure silicone or lanolin.
2. Run an oil patch through the bore with a cleaning rod starting from the breech end. To prevent leading, use a cleaning solvent and brass brush to clean the bore periodically. Follow this cleaning with one or two clean oilpatches. Important: If your gun is equipped with choke tubes, do not use a brass brush to clean the barrels unless a choke tube is installed in each barrel. Barrels that utilize choke tubes must also have the choke tubes removed to clean and oil the threads inside the barrel and the choke tubes themselves. This will protect the threads from being damaged by cleaning tools and also prevent a dirt build up that would cause the choke tube to become difficult to remove from the barrel. Damage can result to choke tubes and barrel when attempting to remove sticky choke tubes.

Never fire your gun without choke tubes snugly tightened in barrels. Do not over tighten choke tubes. Wipe all exposed metal surfaces with an oiled cloth before storing. Do not squirt or pour oil into the inside mechanism because it may hamper proper functioning and will soak the wood. After extended periods of heavy use, your gun should be taken to a qualified gunsmith to have the action disassembled for professional cleaning and lubrication.

3. Care for your wood stock and forearm the same way you would a piece of furniture with the same finish.

STORAGE

Clean thoroughly and oil your gun before storage. Store the gun in a case to prevent scratches and dents. Store in a dry place to prevent corrosion.

AMMUNITION

All Kral Av side-by-side shotguns are designed and tested for the use of factory manufactured shotgun shells. Use shot shells of the proper gauge and chamber length as marked on the barrels. 3" chambers will handle all 3" and 2 3/4" shells. 2 3/4" chambers will handle 2 3/4" shells only.

IMPORTANT

USAGE OF STEEL SHOT

The choke (bore constriction) in all modern shotguns has been established based on the pattern performance of shot shells loaded with lead shot. When using the steel shot shells, you will notice a different performance in pattern density versus the established lead shot pattern, because the steel shot is harder and lighter than lead shot.

You should be aware of the following differences and cautions:

Never shoot steel shot loads in a full choked barrel or full choke tubed barrel. To do so may cause the barrel to swell or rupture. In general, steel shot fired with a modified choke will produce the equivalent of a lead full choke pattern. This will be true of all steel shot size up to and including no. 2. The established improved cylinder chokes will produce the equivalent of a (lead) modified choke pattern.

All steel shot sized larger than no. 2, and including special sized such as "F", "T" etc., should be used only with improved cylinder chokes. These steel shot sizes, when used in improved cylinder chokes, will produce patterns equivalent to (lead) full choke patterns. The established cylinder choke or bore will produce the equivalent of a modified (lead) period

Additional information concerning the use of steel shot is available from Remington, Winchester, Federal and other ammunition companies.

SHIPPING

When returning your gun for service, please take care in packing your gun. Be sure the gun is unloaded. Disassemble your gun, reattach the forearm to the barrels, wrap all parts in paper or other protective material, and place all parts of your gun in the original box. (THIS BOX WILL PROTECT THE GUN BUT IS NOT DESIGNED FOR SHIPPING). Wrap the box in a cardboard box in a strength approved for interstate shipping. Kral Av is not responsible for damage incurred during shipping.

KRAL AV

Tel. : (0.332) 524 66 28 - 524 60 50 - 524 68 70

ÜZÜMLÜ - BEYŞEHİR - KONYA / TÜRKİYE

PARTS To order parts, please furnish the following: Your name, address, telephone number, serial number, make, and model.

When we receive your request, we will send an order from and a parts breakdown with prices.

HAZARDOUS MATERIAL WARNING

Discharging firearms in poorly ventilated areas, cleaning firearms, or handling ammunition, may result in exposure to lead and other substances known to cause birth defects, reproductive harm, and other serious physical injury. Have adequate ventilation at all times. Wash hands thoroughly after exposure.

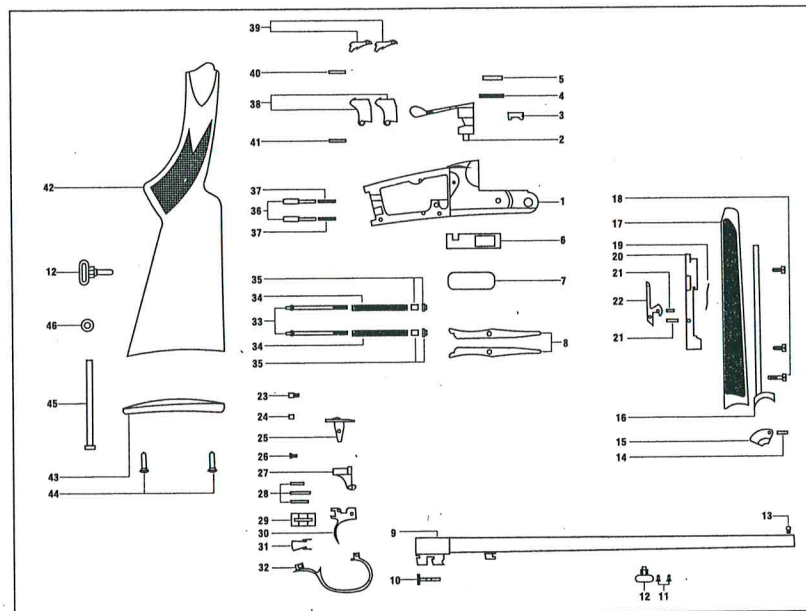

1 Receiver	16 Forearm Iron	31 Trigger Spring
2 Top Lever	17 Forearm	32 Trigger Guard
3 Top Lever Case	18 Forearm Screw	33 Hammer Spring
4 Top Lever Spring	19 Takedown Latch Spring	34 Hammer Pin
5 Top Lever Pin	20 Takedown Latch Bracket	35 Hammer Pin Screw
6 Locking Block	21 Takedown Latch Pin	36 Firing Pin
7 Receiver Plate	22 Takedown Latch	37 Firing Pin Spring
8 Hammer (left-right)	23 Safety Screw	38 Hammer (left-right)
9 Barrel	24 Safety Screw Pin	39 Hammer Inside (left-right)
10 Extractor	25 Safety	40 Hammer Inside Pin
11 Swivel Pin	26 Selector Switch Screw	41 Hammer Screw Pin
12 Swivel	27 Selector Switch	42 Stock
13 Front Bead	28 Pins	43 Butt Plate
14 Cartridge Push Back	29 Safety Plate	44 Butt Plate Screw
15 Extractor Push Rod	30 Trigger	45 Stock Bolt
		46 Stock Bolt Washer

SERVICE AGREEMENT AND LIMITED WARRANTY

Kral Av agrees to service its products free of charge for defects in materials and workmanship in accordance with the service agreement listed below. The obligation of Kral Av under this agreement is limited to the repair or replacement of unserviceable parts and does not cover any incidental or consequential damages. That the express warranty contained herein, Kral Av makes no warranties, express or implied.

Kral Av will repair or replace any unserviceable part(s) for one (1) year from date of purchase and further will supply free parts (wood not included) for an additional four (4) years in accordance with the above warranty satatement, provided your firearm has not been altered, abused, willfully damaged, or damaged by overpressure ammunition. This agreement is not transferable; its benefits apply only to the original purchaser

To obtain free service during the time this agreement is in effect, make sure your firearm is unloaded, and send it to Kral Av.

This agreement and the warranties contained herein are void if your registration card is not received with a copy of your sales slip within 30 days from date of purchase.

Model Number :

Purchase Date:

Gauge or Caliber:

Serial Number:

Purchase Price:

Store Name:

All correspondence regarding service, spare parts or repairs should be directed to:

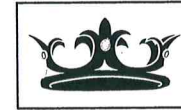

AV SANAYİ MÜTEAHHİTLİK TIBBİ MALZ. SAN ve TİC. LTD. STİ.

Tel.: (0.332) 524 66 28 - 524 68 70 - Fax.: 524 68 71
Meydan Mah. Çeşme Sokak ÜZÜMLÜ - BEYŞEHİR - KONYA

THANK YOU

Thank you for purchasing a Kral Av shotgun. We are sure this gun will bring you years of hunting and/or shooting pleasure. Your satisfaction is the key to our success. Please let us know if we can be of service and please relay any observations about your guns performance or appearance.